

MPI TS3000-IFE | 300 mm Automated Probe Systems

The Dedicated Systems for Product Engineering with IceFreeEnvironment™

FEATURES / BENEFITS

Designed for Variety of On-Wafer Applications

- DC-IV / DC-CV / Pulsed-IV applications
- RF, mmW, load-pull applications & 4-port setup
- IC Design Validation, Failure Analysis in wide temperature range from -60 to 300 °C
- Wafer Level Reliability

Extended Flexibility

- MPI IceFreeEnvironment™ for using MicroPositioners and probe cards simultaneously, even at negative temperature
- Programmable microscope movements for more automation and ease of use
- The shortest cable interface to IC tester
- Minimize the platen-to-chuck distance for mmW & probing with active probes
- Supports film-frame probing

Ergonomic Design and Footprint

- Easy wafer or single DUT loading from the front
- Integrated active vibration isolation
- Completely integrated prober control for faster, safer and convenient system and test operation
- The Safety Test Management (STM™) with automated dew point control
- Reduced footprint due to smart chiller space arrangement
- Instrument shelf option for shorter cables and higher measurement dynamic



STAGE SPECIFICATIONS

Chuck XY Stage (Programmable)

| | |
|----------------|---|
| Travel range | 310 mm x 335 mm (12.2 x 13.19 in) |
| Resolution | 0.5 µm |
| Accuracy | < 2.0 µm (0.08 mils) |
| Repeatability | < 1.0 µm |
| XY stage drive | Closed-loop high precision stepper motors |
| Speed* | Slowest: 10 µm / sec Fastest: 50 mm / sec |

Chuck Z Stage (Programmable)

| | |
|---------------|---|
| Travel range | 30 mm (1.18 in) |
| Resolution | 0.2 µm |
| Accuracy | < 2.0 µm |
| Repeatability | < 1.0 µm |
| Z stage drive | Closed-loop high precision stepper motor |
| Speed* | Slowest: 10 µm / sec Fastest: 20 mm / sec |
| Guider | Precision ball bearings |

*The speed is instantaneous speed, not average speed. There is accelerate and decelerate time when moving.

STAGE SPECIFICATIONS

Chuck Theta Stage (Programmable)

| | |
|-------------------|---|
| Travel range | ± 5.0° |
| Resolution | 0.0001° (0.24 µm @ 300 mm edge) |
| Accuracy | < 2.0 µm (measured at the edge of the 300 mm chuck) |
| Repeatability | < 1.0 µm |
| Theta stage drive | High resolution stepper motor with linear encoder feedback system |

MICROSCOPE MOVEMENT

XYZ Programmable

| | |
|--------------------|---------------------------|
| XY - Travel range* | 50 x 50 mm / 300 x 300 mm |
| Resolution | 1 µm (0.04 mils) |
| Repeatability | ≤ 2 µm (0.08 mils) |
| Accuracy | ≤ 5 µm (0.2 mils) |
| Z - Travel range | 140 mm |
| Resolution | 0.05 µm (0.002 mils) |
| Repeatability | ≤ 2 µm (0.08 mils) |
| Accuracy | ≤ 4 µm (0.16 mils) |

*In case of ShieldEnvironment™ X x Y: 25 mm x 25 mm

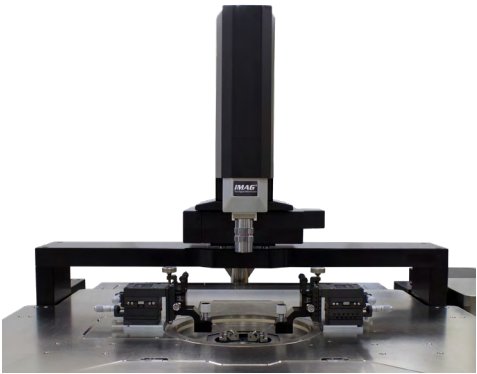

PROBE PLATEN

Specifications

| | |
|------------------------------|--|
| Material | Nickel plated steel |
| Chuck top to platen top | Min. 28 mm |
| Platen cooling | Fully integrated CDA cooling, by using the chiller CDA |
| Configuration | Probe card holder 4.5 x 11" and/or MicroPositioners |
| Max. No. of MicroPositioners | 10x DC MicroPositioners or 4x DC + 4x HF MicroPositioner Setup |
| RF MicroPositioner mounting | Magnetic with guided rail |
| DC MicroPositioner mounting | Magnetic |

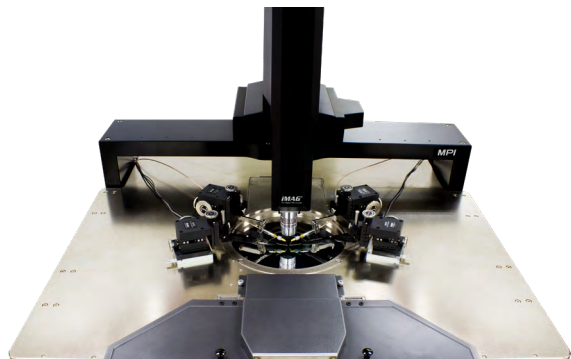
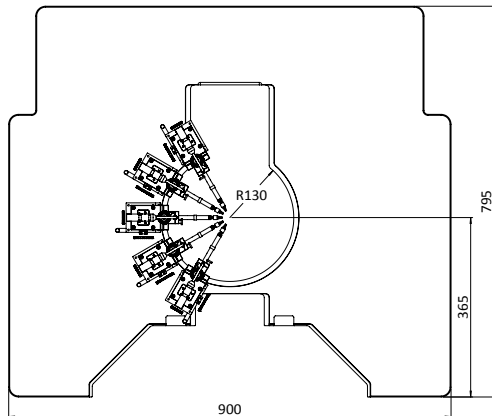

Large Probe Platen supporting up to 10x DC or 4x DC + 4x RF MicroPositioners or standard 4.5" probe card holder

KEY FEATURES

IceFreeEnvironment™

MPI IceFreeEnvironment™ provides unique capability to perform measurements with probe cards and MicroPositioners simultaneously, especially at negative temperatures down to -60 °C.

Internal node probing with active/passive high impedance probes is very convenient.

The optimized design with minimal tip drop for highest dynamic range and gamma of mmWave and Load Pull measurements make the system an ideal choice for RF/mmW applications on 300 mm wafers.

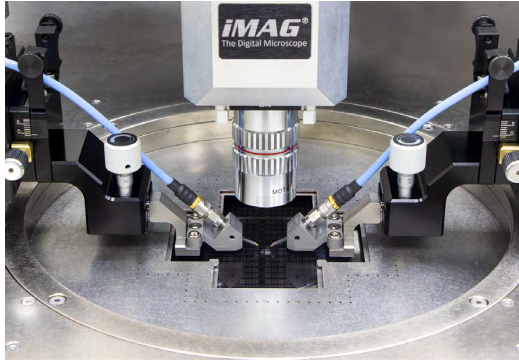

Wafer Loading

Loading or unloading of 150, 200 or 300 mm wafers or substrates is straight forward and intuitive. Special designed chucks allowing easy single ICs or wafer fragments loading in the front. Furthermore MPI SmartVacuum™ technology allows automated wafer size or single Die recognition and protects the wafer in case of power interruptions or inexperience operators from releasing the vacuum inside the IceFreeEnvironment™.

No roll-out stage allows for a simple method of automation for RF calibration and probe card cleaning. Easy access to the AUX chucks for handling of calibration substrates, cleaning or contact check pads.

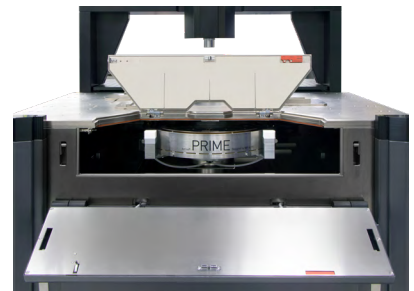

Integrated Controls

The thermal chuck can be operated by using the fully integrated touchscreen display, placed at convenient location in front of the operator for fast operation and immediate feedback.

The intelligent hardware control panel is completely integrated into the probe system and is designed to provide faster, safer and convenient system control and test operation.

The Keyboard and mouse are strategically located to control the software and it can also control the Windows® based instrumentation.

USB connection to the systems controller is located right in front for convenient data exchange.



Probe Hover Control™

MPI Probe Hover Control PHC™ allows easy manual control of probe contact and separation to wafer. Separation distance can accurately control with micrometer feedback for probe to wafer/pad positioning. Ease of use guarantees the safest operation by minimizing error during critical set-up and probe change operations.



Minimized CDA Consumption

With the ERS patented technology, using the chiller for purging the IceFreeEnvironment™, the CDA consumption is reduced by as much as 50%. Nitrogen purging is also possible by using separate, automated valve. This “refurbished” CDA is used in addition for probe platen and probe card cooling.

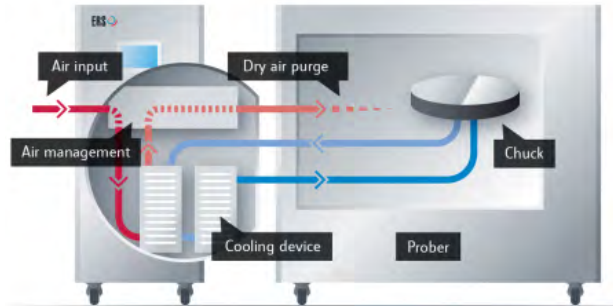

* Picture is courteously provided by ERS.

SENTIO® - Probe Station Control Software

MPI automated engineering probe systems are controlled by a unique and revolutionary, multi-touch operation SENTIO® Software Suite – simple and intuitive operation saves significant training time, the Scroll, Zoom, and Move commands mimic modern smart mobile devices and allows everyone to become an expert in just minutes. Switching between the active application and the rest of the APPs is just a matter of a simple finger sweep.

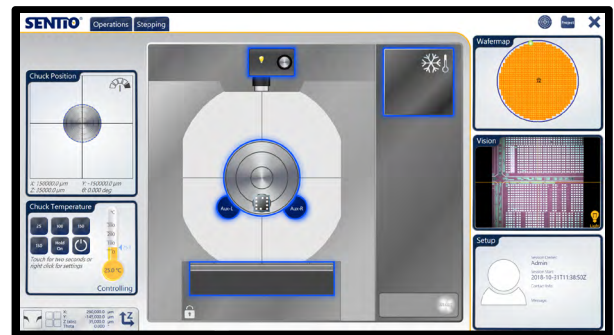

QAlibria® - RF Calibration Software

By implementing intuitive multi-touch operation, QAlibria® provides crisp and clear guidance to the RF calibration process, minimizes configuration mistakes and helps to reach accurate calibration results in fastest time. QAlibria® offers industry standard and advanced calibration methods. QAlibria® includes TOSM (SOLT), TMR, TMRR methods, and 4-port calibration capability additionally to the integration of NIST StatistiCal calibration packages providing easy access to the NIST multiline TRL metrology-level calibration and uncertain analysis.

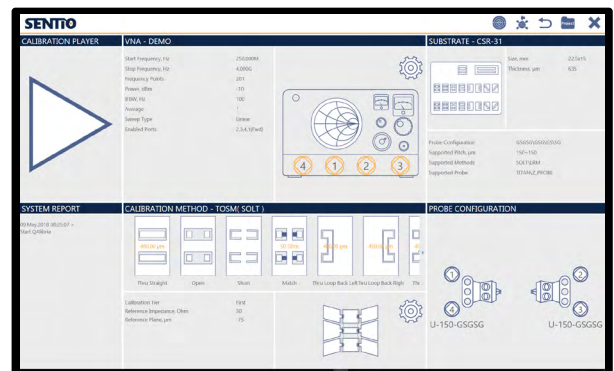

OPTIONAL FEATURES

DarkBox

DarkBox allows light sensitive measurement capability and in case of TS3000-IFE interlock system for safety measurements up to 10kV and 600A. See all dimensions on the last page.



Vertical Control Environment™ (VCE™)

The VCE™ allows the probing area to be observed from the side for safe operation. It automatically detects the height of the tips and defines the position of the chuck contact. The wizard-guided setup procedure takes into account working with probe cards and DC or RF probes. It saves time during initial contacting and prevents damage to probes or pads, especially in the covered MPI ShieldEnvironment™.

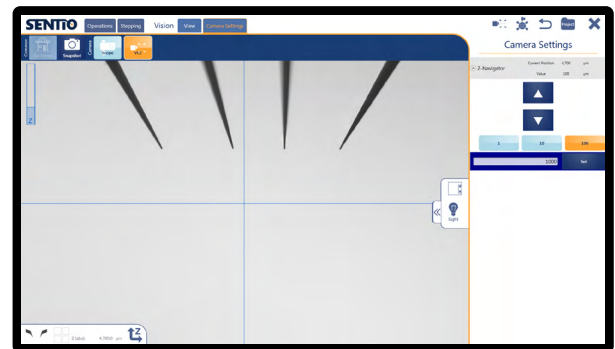

mDrive™

In addition to the standard joystick control, mDrive™ provides a truly intuitive, manual, one or two hands operation of all existing programmable stages, such as chuck, scope or MicroPositioners. X- and Y-axis fine control is available for the selected stage, where Z safety function requires additional enabling.



THZ-Selection

It converts TS3000-IFE system into a dedicated, mmW and THz probe station, as the first one on the market:

- Automated testing of 300 mm wafers with unsurpassed measurement accuracy is possible now
- The MPI THZ-Selection incorporates MPI's innovative design of frequency extender's integration, developed for TS200-THZ, which hovers the extender over the entire 300 mm wafer
- This minimizes the distance to the DUT to a minimum in order to provide best possible measurement directivity and accuracy

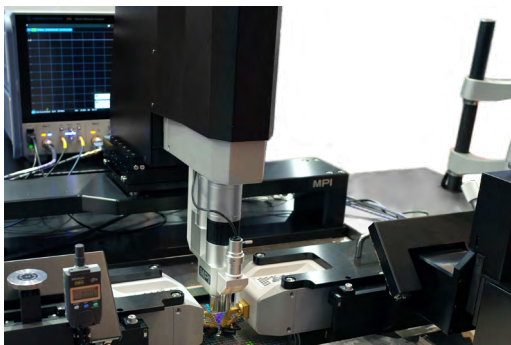

NON-THERMAL CHUCKS

| Wafer Chuck | Standard | Triaxial |
|----------------------------------|---|------------------|
| Connectivity | Coax BNC (f) | Kelvin Triax (f) |
| Diameter | 310 mm with 2 integrated AUX areas | |
| Material | Nickel plated aluminum (flat with 0.5 mm holes) | |
| Chuck surface | Planar with 0.5 mm diameter holes in centric sections | |
| Vacuum holes sections (diameter) | 4, 24, 48, 72, 96, 120, 144, 168, 192, 216, 240, 264, 288 mm | |
| SmartVacuum™ distribution | In front for single DUT 5x5 mm (4 holes) and 75 mm (3 in) In center for 150, 200, 300 mm (6, 8, 12 in) | |
| Surface planarity | ≤± 5 μm** | |
| Rigidity | < 15 μm / 10 N @edge | |

*Single DUT testing requires higher vacuum conditions dependent upon testing application.

**By using SENTIO® topography

Triaxial RF Wafer Chuck

| | |
|----------------------------------|---|
| Connectivity | Kelvin Triax (f) |
| Diameter | 310 mm with 2 integrated AUX chucks |
| Material | Nickel plated aluminum (flat with 0.5 mm holes) |
| Chuck surface | Planar with 0.5 mm diameter holes in centric sections |
| Vacuum holes sections (diameter) | 4, 24, 48, 72, 96, 120, 144, 168, 192, 216, 240, 264, 288 mm |
| SmartVacuum™ distribution | In front for single DUT 5x5 mm (4 holes) and 75 mm (3 in) In center for 150, 200, 300 mm (6, 8, 12 in) |
| Surface planarity | ≤± 5 μm** |
| Rigidity | < 15 μm / 10 N @edge |

*Single DUT testing requires higher vacuum conditions dependent upon testing application.

**By using SENTIO® topography

Auxiliary Chuck

| | |
|------------------------|---|
| Quantity | 2 AUX chucks |
| Position | Integrated to front side of main chuck |
| Substrate size (W x L) | Max. 25 x 25 mm (1 x 1 in) |
| Material | Ceramic, RF absorbing material for accurate calibration |
| Surface planarity | ≤± 5 μm |
| Vacuum control | Controlled independently, separate from chucks |

Electrical Specification (Coax)

| | |
|---|--|
| Operation voltage | In accordance with EC 61010, certificates for higher voltages available upon request |
| Maximum voltage between chuck top and GND | 500 V DC |
| Isolation | > 2 GΩ |

Electrical Specification (Triax)

| | |
|-----------------|-----------|
| Chuck Isolation | At 10 V |
| Force-to-Guard | > 5 T Ohm |
| Guard-to-Shield | > 1 T Ohm |
| Force-to-Shield | > 5 T Ohm |

THERMAL CHUCKS

Specifications of MPI ERS AirCool® PRIME Technology

| | Ambient to 200/300 °C | 20 °C to 200/300 °C | Ambient to 200/300 °C | 20 °C to 200/300 °C |
|--|---|--|--|--|
| Chuck type | RF | RF | Ultra low noise | Ultra low noise |
| Connectivity | Kelvin Triax (f) | Kelvin Triax (f) | Kelvin Triax (f) | Kelvin Triax (f) |
| Temperature control method | Cooling air / Resistance heater | Cooling air / Resistance heater | Cooling air / Resistance heater | Cooling air / Resistance heater |
| Coolant | Air (user supplied) | Air (user supplied) | Air (user supplied) | Air (user supplied) |
| Smallest temperature selection step | 0.1 °C | 0.1 °C | 0.1 °C | 0.1 °C |
| Chuck temperature display resolution | 0.01 °C | 0.01 °C | 0.01 °C | 0.01 °C |
| External touchscreen display operation | Yes | Yes | Yes | Yes |
| Temperature stability | ±0.08 °C | ±0.08 °C | ±0.08 °C | ±0.08 °C |
| Temperature accuracy | ±0.1 °C | 0.1 °C | 0.1 °C | 0.1 °C |
| Control method | Low noise DC/PID | Low noise DC/PID | Low noise DC/PID | Low noise DC/PID |
| Chuck pinhole surface plating: 200°C / 300°C | Nickel / Gold | Nickel / Gold | Nickel / Gold | Nickel / Gold |
| SmartVacuum™ distribution | In front for single DUT 5x5 mm (4 holes) and 75 mm (3 in) In center for 150, 200, 300 mm (6, 8, 12 in) | | | |
| Temperature sensor | Pt100 1/3DIN, 4-line wired | Pt100 1/3DIN, 4-line wired | Pt100 1/3DIN, 4-line wired | Pt100 1/3DIN, 4-line wired |
| Temperature uniformity | < ±0.5 °C at ≤ 200 °C < ±1 °C at > 200 °C | < ±0.5 °C at ≤ 200 °C < ±1 °C at > 200 °C | < ±0.5 °C at ≤ 200 °C < ±1 °C at > 200 °C | < ±0.5 °C at ≤ 200 °C < ±1 °C at > 200 °C |
| Surface flatness and base parallelism | < ±12 μm | < ±12 μm | < ±12 μm | < ±12 μm |
| Max. Voltage between | | | | |
| Force-to-GND | 600 V DC | 600 V DC | 600 V DC | 600 V DC |
| Force-to-Guard | 100 V DC | 100 V DC | 600 V DC | 600 V DC |
| Guard-to-GND | 400 V DC | 400 V DC | 400 V DC | 400 V DC |
| Heating rates* | 35 to 200 °C < 16 min 35 to 300 °C < 29 min | 20 to 200 °C < 19 min 20 to 300 °C < 30 min | 35 to 200 °C < 17 min 35 to 300 °C < 33 min | 20 to 200 °C < 21 min 20 to 300 °C < 34 min |
| Cooling rates* | 200 to 35 °C < 24 min 300 to 35 °C < 27 min | 200 to 20 °C < 35 min 300 to 20 °C < 42 min | 200 to 35 °C < 27 min 300 to 35 °C < 31 min | 200 to 20 °C < 37 min 300 to 20 °C < 50 min |
| Leakage @ 10 V | N/A | N/A | < 15 fA at 25 °C < 30 fA at 200 °C < 50 fA at 300 °C | < 15 fA at 25 °C < 30 fA at 200 °C < 50 fA at 300 °C |
| Electrical isolation | > 5 T Ω at 25 °C > 1 T Ω at 200 °C > 0.5 T Ω at 300 °C | > 5 T Ω at 25 °C > 1 T Ω at 200 °C > 0.5 T Ω at 300 °C | N/A | N/A |
| Capacitance | | | | |
| Force-to-Guard | < 1600 pF | < 1600 pF | < 600 pF | < 600 pF |
| Guard-to-Shield | < 2000 pF | < 2000 pF | < 2000 pF | < 2000 pF |

*Typical data for all chucks based on FPS requirements.

Specifications of MPI ERS AirCool® PRIME with Fusion Chiller Technology

| | -10 °C to 200/300 °C | -40 °C to 200/300 °C | -60 °C to 200/300 °C |
|--|--|--|--|
| Chuck type | RF | RF | RF |
| Connectivity | Kelvin Triax (f) | Kelvin Triax (f) | Kelvin Triax (f) |
| Temperature control method | Cooling air / Resistance heater | Cooling air / Resistance heater | Cooling air / Resistance heater |
| Coolant | Air (user supplied) | Air (user supplied) | Air (user supplied) |
| Smallest temperature selection step | 0.1 °C | 0.1 °C | 0.1 °C |
| Chuck temperature display resolution | 0.01 °C | 0.01 °C | 0.01 °C |
| External touchscreen display operation | Yes | Yes | Yes |
| Temperature stability | ±0.08 °C | ±0.08 °C | ±0.08 °C |
| Temperature accuracy | 0.1 °C | 0.1 °C | 0.1 °C |
| Control method | Low noise DC/PID | Low noise DC/PID | Low noise DC/PID |
| Interfaces | RS232C | RS232C | RS232C |
| Chuck pinhole surface plating: 200°C / 300°C | Nickel / Gold | Nickel / Gold | Nickel / Gold |
| SmartVacuum™ distribution | In front for single DUT 5x5 mm (4 holes) and 75 mm (3 in) In center for 150, 200 and 300 mm (6, 8, 12 in) | | |
| Temperature sensor | Pt100 1/3DIN, 4-line wired | Pt100 1/3DIN, 4-line wired | Pt100 1/3DIN, 4-line wired |
| Temperature uniformity | < ±0.5 °C at ≤ 200 °C < ±1 °C at > 200 °C | < ±0.5 °C at ≤ 200 °C < ±1 °C at > 200 °C | < ±0.5 °C at ≤ 200 °C < ±1 °C at > 200 °C |
| Surface flatness and base parallelism | < ±12 μm | < ±12 μm | < ±12 μm |
| Max. Voltage between | | | |
| Force-to-GND | 600 V DC | 600 V DC | 600 V DC |
| Force-to-Guard | 100 V DC | 100 V DC | 100 V DC |
| Guard-to-GND | 400 V DC | 400 V DC | 400 V DC |
| Heating rates* | | | |
| 25 °C | -10 to 25 °C < 3 min | -40 to 25 °C < 5 min | -60 to 25 °C < 6 min |
| 200 °C | | 25 to 200 °C < 16 min | |
| 300 °C | | 25 to 300 °C < 28 min | |
| Cooling rates* | | | |
| AC3 Mode | 300 °C | 300 to 25 °C < 26 min | 300 to 25 °C < 24 min |
| | 200 °C | 200 to 25 °C < 21 min | 200 to 25 °C < 22 min |
| | 25 °C | 25 to -10 °C < 11 min | 25 to -40 °C < 18 min |
| TURBO Mode | 300 °C | 300 to 25 °C < 26 min | 300 to 25 °C < 23 min |
| | 200 °C | 200 to 25 °C < 21 min | 200 to 25 °C < 21 min |
| | 25 °C | 25 to -10 °C < 11 min | 25 to -40 °C < 16 min |
| Leakage @ 10 V | N/A | N/A | N/A |
| Electrical isolation | > 5 T Ω at 25 °C or below > 1 T Ω at 200 °C, > 0.5 T Ω at 300 °C | | |
| Capacitance | | | |
| Force-to-Guard | < 1600 pF | < 1600 pF | < 1600 pF |
| Guard-to-Shield | < 2000 pF | < 2000 pF | < 2000 pF |

*Typical data for all chucks based on FPS requirements.

Specifications of MPI ERS AirCool® PRIME with Fusion Chiller Technology

| | -10 °C to 200/300 °C | -40 °C to 200/300 °C | -60 °C to 200/300 °C |
|--|--|--|--|
| Chuck type | Ultra low noise | Ultra low noise | Ultra low noise |
| Connectivity | Kelvin Triax (f) | Kelvin Triax (f) | Kelvin Triax (f) |
| Temperature control method | Cooling air / Resistance heater | Cooling air / Resistance heater | Cooling air / Resistance heater |
| Coolant | Air (user supplied) | Air (user supplied) | Air (user supplied) |
| Smallest temperature selection step | 0.1 °C | 0.1 °C | 0.1 °C |
| Chuck temperature display resolution | 0.01 °C | 0.01 °C | 0.01 °C |
| External touchscreen display operation | Yes | Yes | Yes |
| Temperature stability | ±0.08 °C | ±0.08 °C | ±0.08 °C |
| Temperature accuracy | 0.1 °C | 0.1 °C | 0.1 °C |
| Control method | Low noise DC/PID | Low noise DC/PID | Low noise DC/PID |
| Interfaces | RS232C | RS232C | RS232C |
| Chuck pinhole surface plating: 200°C / 300°C | Nickel / Gold | Nickel / Gold | Nickel / Gold |
| SmartVacuum™ distribution | In front for single DUT 5x5 mm (4 holes) and 75 mm (3 in) In center for 150, 200 and 300 mm (6, 8, 12 in) | | |
| Temperature sensor | Pt100 1/3DIN, 4-line wired | Pt100 1/3DIN, 4-line wired | Pt100 1/3DIN, 4-line wired |
| Temperature uniformity | < ±0.5 °C at ≤ 200 °C < ±1 °C at > 200 °C | < ±0.5 °C at ≤ 200 °C < ±1 °C at > 200 °C | < ±0.5 °C at ≤ 200 °C < ±1 °C at > 200 °C |
| Surface flatness and base parallelism | < ±12 μm | < ±12 μm | < ±12 μm |
| Max. Voltage between | | | |
| Force-to-GND | 600 V DC | 600 V DC | 600 V DC |
| Force-to-Guard | 600 V DC | 600 V DC | 600 V DC |
| Guard-to-GND | 400 V DC | 400 V DC | 400 V DC |
| Heating rates* | | | |
| 25 °C | -10 to 25 °C < 3 min | -40 to 25 °C < 5 min | -60 to 25 °C < 6 min |
| 200 °C | | 25 to 200 °C < 18 min | |
| 300 °C | | 25 to 300 °C < 31 min | |
| Cooling rates* | | | |
| AC3 Mode | 300 °C | 300 to 25 °C < 28 min | 300 to 25 °C < 28 min |
| | 200 °C | 200 to 25 °C < 23 min | 200 to 25 °C < 24 min |
| | 25 °C | 25 to -10 °C < 12 min | 25 to -40 °C < 20 min 25 to -60 °C < 40 min |
| TURBO Mode | 300 °C | 300 to 25 °C < 28 min | 300 to 25 °C < 27 min |
| | 200 °C | 200 to 25 °C < 23 min | 200 to 25 °C < 23 min |
| | 25 °C | 25 to -10 °C < 12 min | 25 to -40 °C < 18 min 25 to -60 °C < 37 min |
| Leakage @ 10 V | | | |
| -10, -40 or -60 °C | < 30 fA | < 30 fA | < 30 fA |
| 25 °C | < 15 fA | < 15 fA | < 15 fA |
| 200 °C | < 30 fA | < 30 fA | < 30 fA |
| 300 °C | < 50 fA | < 50 fA | < 50 fA |
| Capacitance | | | |
| Force-to-Guard | < 600 pF | < 600 pF | < 600 pF |
| Guard-to-Shield | < 2000 pF | < 2000 pF | < 2000 pF |

*Typical data for all chucks based on FPS requirements.

THERMAL CHUCKS DIMENSIONS

System Controller / Chiller Dimensions and Power / Air Consumption

| System type | W x D x H (mm) | Weight (kg) | Power cons. (VA) | max. Air flow* (l/min) | CDA dew Point |
|-------------------------------|----------------------------|-------------|------------------|------------------------|-------------------|
| Ambient | 300 x 360 x 135 | 12 | 1200 | 400 | ≤ 0 °C |
| 20 °C, -10 °C to 200 / 300 °C | 300 x 360 x 135 | 12 | 1200 | 400 | ≤ -30 °C |
| -40 to 200 / 300 °C | 420 x 500 x 1020 | 140 | 2650 | 400 | ≤ -40 °C / -70 °C |
| -60 to 200 / 300 °C | 420 x 500 x 1020 | 140 | 2400 | 450 | ≤ -40 °C |
| Electrical primary connection | 100 to 240 VAC auto switch | | | | |
| Electrical frequency | 50 Hz / 60 Hz | | | | |
| Compressed air supply | 6.0 bar (0.8 MPa, 87 psi) | | | | |



ERS AirCool® Fusion*, Controller Integrated Chiller -40 °C / -60 °C



ERS AirCool® Fusion*, Controller Integrated Chiller -10 °C

*ERS electronic GmbH patented solution



ERS and MPI's joint product AirCool® PRIME Chuck won "Electronics Industry Awards 2018" in the category, "Test, Measurement and Inspection Product of the year".

TYPICAL TRANSITION TIME

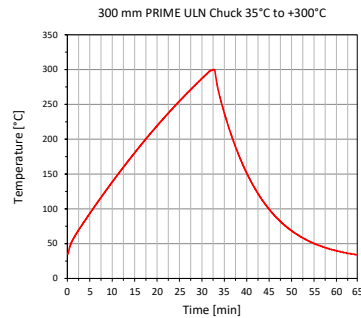
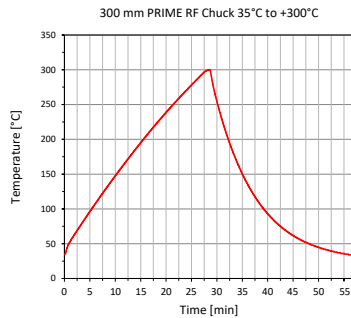
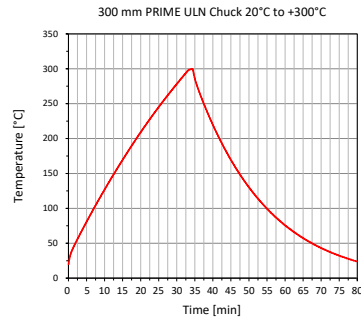
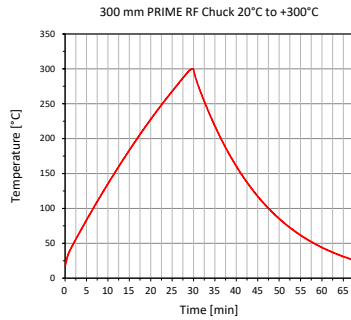

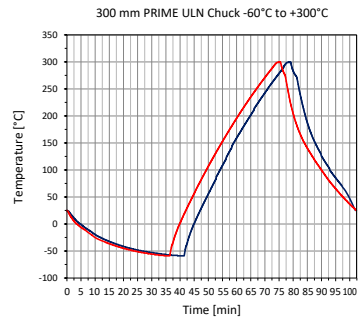
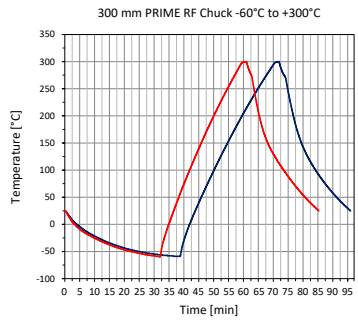
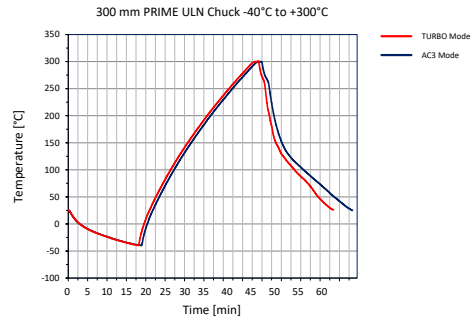
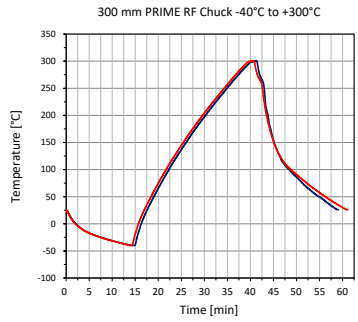
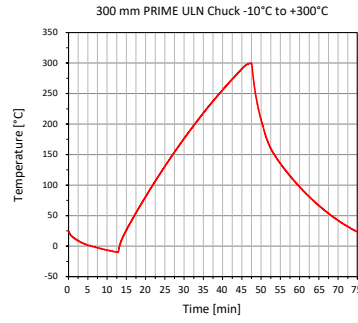
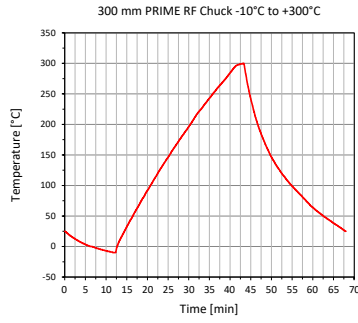

SYSTEM CONTROLLER SPECIFICATIONS

| | |
|-------------------------|--|
| CPU | Intel Core i7 |
| RAM | 16 GB |
| 64 bit operating system | Windows 10 Professional (English) 64 bit |
| Storage | 500 GB SSD |
| LAN | 1 x internal, 1 x external TCP/IP port |
| USB Ports | 3 x internal, 1 x external |
| GPIB interface | Optional |

SUPPORTED SOFTWARE PLATFORMS

| | |
|----------------|--|
| Drivers | WaferPro / IC-CAP & EasyEXPERT from Keysight, BSIMPro & NoisePro from ProPlus, ACS from Keithley |
| Emulation mode | Available for various prober control software* |

* Please contact your local support for more details.

FACILITY REQUIREMENTS

General Probe System

| | |
|----------------|---------------------------------|
| Power | 100-240 V AC nominal ; 50/60 Hz |
| Vacuum | -0.9 bar |
| Compressed air | 6.0 bar |

REGULATORY COMPLIANCE

3rd party, TÜV tested according to

- IEC 61010-1: 2010 + Am1:2016; EN 61010-1: 2010; IEC/EN 61010-2-010: 2014; IEC/EN 61010-2-081: 2015; EN ISO 12100: 2010; UL 61010-1: 2012/R: 2016-04; UL 61010-2-010: 2015; CAN/CSA-C22.2 No. 61010-1: 2012/U2: 2016-04; CAN/CSA-C22.2 No. 61010-2-010:2015

and certified for CE and US/Canada (NRTL), SEMI S2 and S8.

Copies of certificates are available on request

WARRANTY

- Warranty*: 12 months
- Extended service contract: contact MPI Corporation for more information

*See MPI Corporation's Terms and Conditions of Sale for more details.

PHYSICAL DIMENSIONS

TS3000-IFE

| | |
|-------------------------------|--|
| System dimensions (W x D x H) | 1400 x 1115 x 1550 mm (55.1 x 43.9 x 61.0 in) |
| Weight | 850 kg (includes system, accessories, and chiller) |

*Can increase depends on operator manual adjustment or interaction.

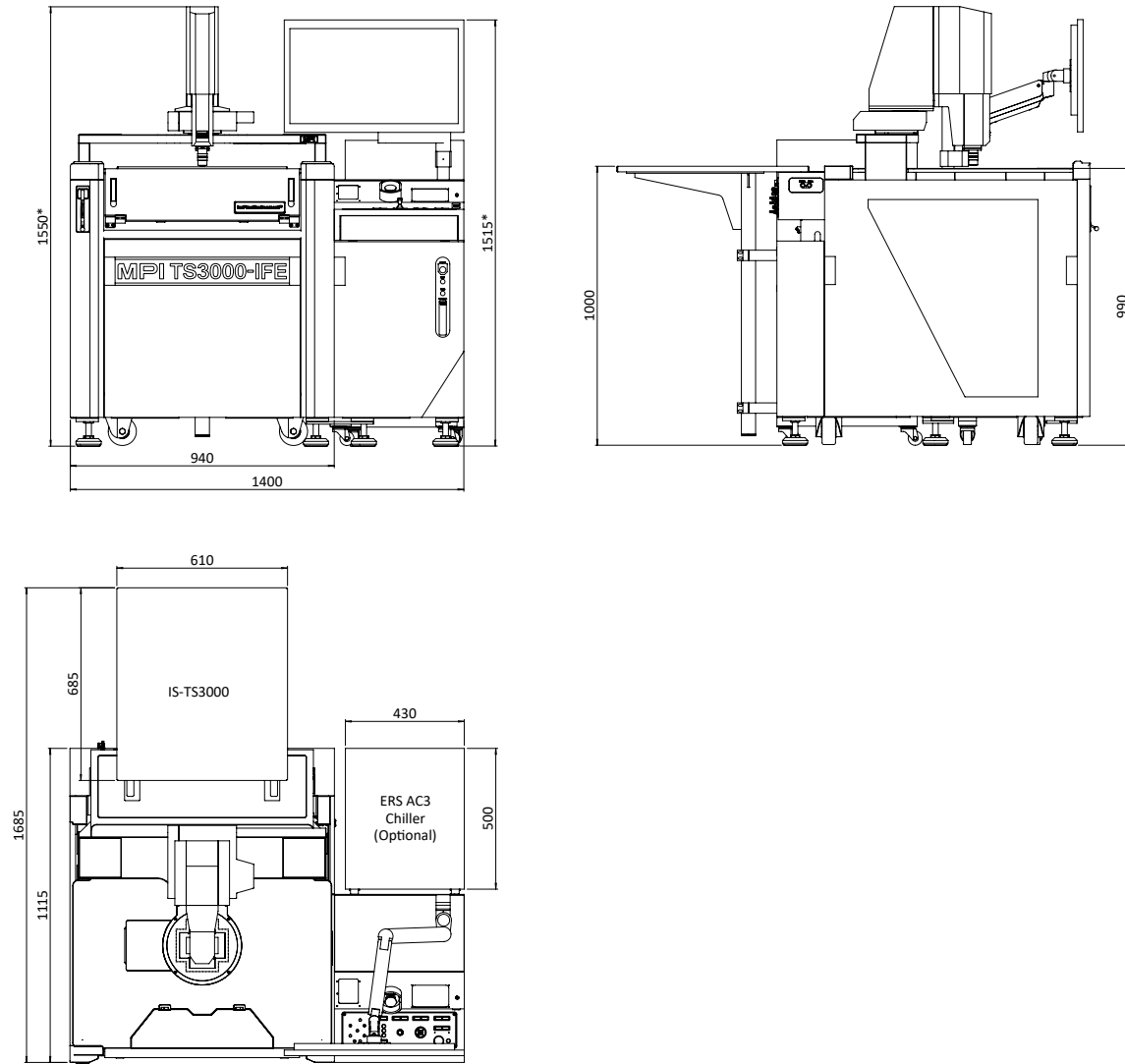

TS3000-IFE with DarkBox

| | |
|-------------------------------|---|
| System dimensions (W x D x H) | 1640 x 1280 x 1700 mm (64.6 x 50.4 x 66.9 in) |
| Weight | 905 kg (includes system and accessories) |

*Can increase depends on operator manual adjustment or interaction.
 **Valid height if the signal tower option is selected.

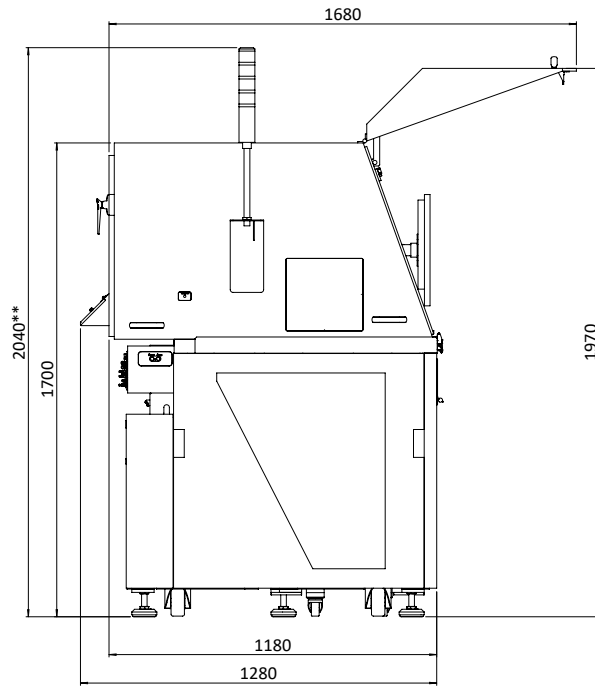
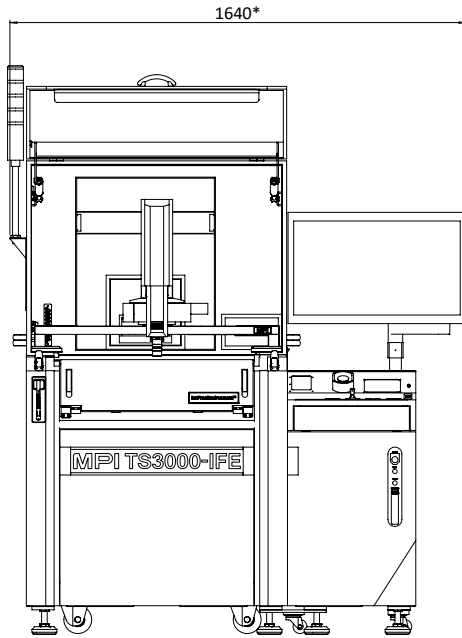

Direct contact:
 Asia region: ast-asia@mpi-corporation.com
 EMEA region: ast-europe@mpi-corporation.com
 America region: ast-americas@mpi-corporation.com

MPI global presence: for your local support, please find the right contact here:
www.mpi-corporation.com/ast/support/local-support-worldwide

© 2024 Copyright MPI Corporation. All rights reserved.

MPI Global Presence

